

General Surgical Instruments



TREU = INSTRUMENTE



Drill Bits

ø mm	AO shaft	Length mm	round shaft	Length mm
1.1	9-010	60 / 35	9-040	45 / 30
1.5	9-012	85 / 60	9-042	70 / 55
2.0	9-014	100 / 75	9-044	85 / 70
2.5	9-016	110 / 85	9-046	95 / 80
2.7	9-018	100 / 75	9-048	85 / 70
3.2	9-020	145 / 120	9-050	130 / 115
3.2	9-021	195 / 170	9-051	180 / 165
3.5	9-022	100 / 85	9-052	95 / 80
3.5	9-023	195 / 170	9-053	180 / 165
4.5	9-026	145 / 120	9-056	130 / 115
4.5	9-027	195 / 170	9-057	180 / 165



Taps

for screws ø mm	AO shaft	T-bar
1.5 dental	9-071	
2.0 dental	9-072	
2.7	9-073	9-060
3.5 thread pitch 1.25	9-074	9-062
3.5 thread pitch 1.75	9-075	9-064
4.0 thread pitch 1.75	9-076	9-065
4.5 short thread	9-077	
4.5 long thread	9-078	9-068
6.5	9-079	9-070

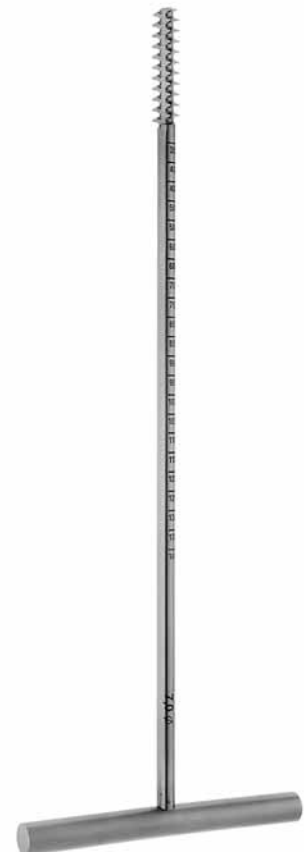



TREU = INSTRUMENTE

Three-jaw Chucks with Handle for insertion of Steinmann Pins and Schanz Screws



9-088
T-Handle (9-089) with Jacobs three-jaw Chuck (9-087) and Key (9-0870), complete cannulated 4,1 mm



to be tightened by hand or by key

9-086
T-Handle (9-089) with Universal three-jaw Chuck (9-875) and Key (9-0870), complete cannulated 4,1 mm

9-090
T-Handle (9-089) with Universal three-jaw Chuck (9-091) and Key (9-0910), complete cannulated 4,1 mm



9-085
T-Handle (9-0891) with Jacobs three-jaw Chuck (9-084) and Key (9-0840), complete



9-083
Drill-Handle (9-0892) with Jacobs three-jaw Chuck (9-084) and Key (9-0840), complete



TREU - INSTRUMENTE

Three-jaw Chucks



9-087
Jacobs three-jaw Chuck
opening max. 6,35 mm



9-0875
Universal three-jaw Chuck
to be tightened by hand or by key
opening max. 6,35 mm



9-0870
Key for Jacobs Chuck
(9-087 and 9-0875)



9-091
Universal three-jaw Chuck
opening max. 7,0 mm



9-0910
Key for Universal Chuck
(9-091)



9-084
Jacobs three-jaw Chuck
opening max. 4,5 mm



9-0840
Key for Jacobs Chuck
(9-084)



TREU = INSTRUMENTE

Drill Bit and Tap Handles



9-092 Tap Handle for AO shaft

9-093 Tap Handle cannulated



9-094 Tap Handle for AO shaft



9-096 Tap Handle for Dental shaft



TREU = INSTRUMENTE

Instruments for Screw Fixation

Countersinks
For preparing the seat for the screw head



9-100 For Mini Screws 1.5 mm and 2.0 mm \varnothing Tip 1.1 mm \varnothing



9-102 For Small Screws 2.7, 3.5 and 4.0 mm \varnothing Tip 2.0 mm



9-104 For Malleolar Screws Tip 3.2 mm \varnothing

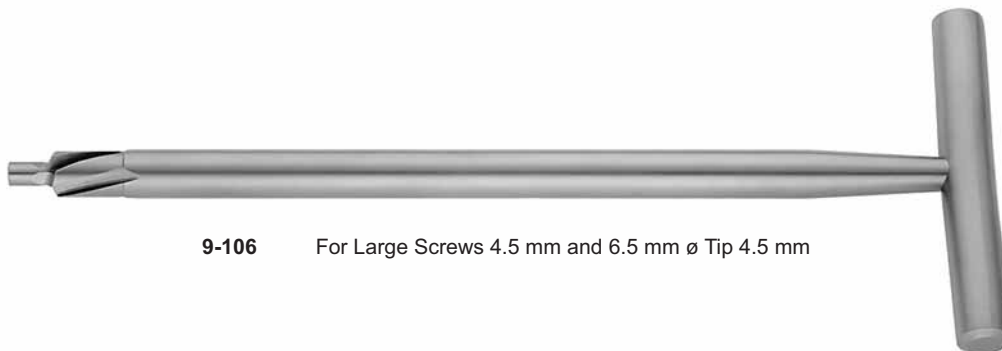

9-106 For Large Screws 4.5 mm and 6.5 mm \varnothing Tip 4.5 mm



9-110 Depth Gauge for Mini Screws
9-112 Depth Gauge for Small Screws
9-114 Depth Gauge for Large Screws



4-184 Screw Forceps



9-116 Sharp Hook
for checking alignment of fracture ends and
for removing in-grown tissue in screw heads



TREU = INSTRUMENTE

Screw Drivers

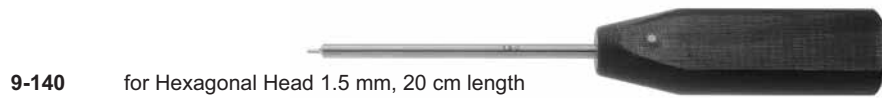

9-140 for Hexagonal Head 1.5 mm, 20 cm length



9-168 Screw Driver for 3,5 and 4,0 mm cannulated screws

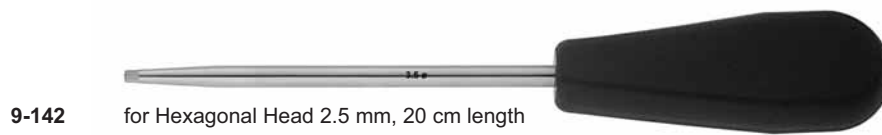

9-142 for Hexagonal Head 2.5 mm, 20 cm length

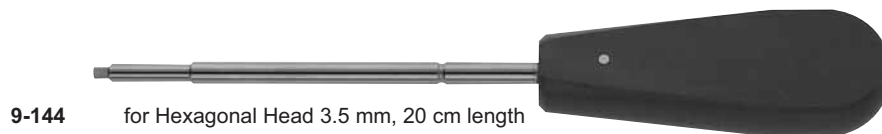

9-144 for Hexagonal Head 3.5 mm, 20 cm length

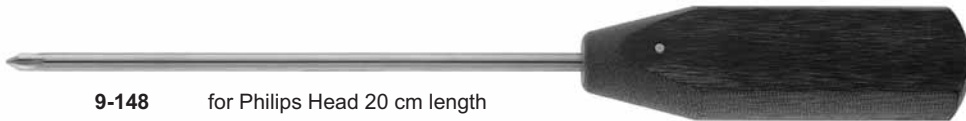

9-148 for Phillips Head 20 cm length

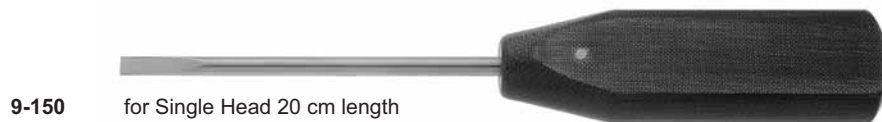

9-150 for Single Head 20 cm length



9-152 Slotted Head 20 cm length



A



B



C



D



- | | | |
|-------|---|--|
| 9-158 | A | Screw Driver Williams for Phillips Head, 23,0 cm |
| 9-160 | B | Screw Driver Williams for Slotted Head, 23,0 cm |
| 9-162 | C | Screw Driver Williams for Single Head, 23,0 cm |
| 9-164 | D | Screw Driver Williams for Hexagonal Head 3.5 mm, 23,0 cm |



TREU = INSTRUMENTE

Instruments for Screw Fixation



9-170 Screw Driver for Mini Screws 1.5 mm



9-171 Holding Sleeve 1.5 mm



9-167 Screwdriver Sleeve for 9-169



9-169 Screw Driver for 3,5 mm screws



9-172 Screw Driver 2.5 mm



9-173 Holding Sleeve 2.5 mm
for 9-172



9-174 Screw Driver Shaft 2.5 mm



9-176 Screw Driver Shaft 3.5 mm



9-178 Screw Driver Shaft 1.5 mm



TREU = INSTRUMENTE



4-184 Screw Forceps self holding



9-179 Bone Screw Holding Forceps

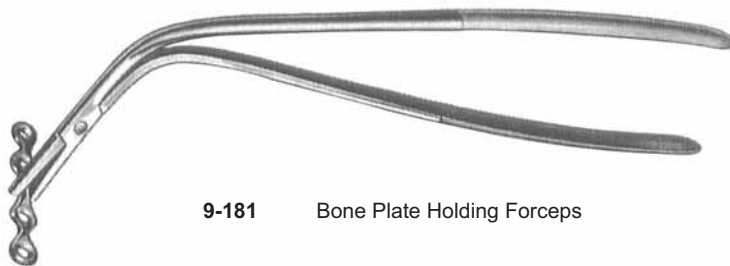

9-181 Bone Plate Holding Forceps



TREU = INSTRUMENTE

Instruments for Screw Fixation Drill Sleeves and Drill Guides



- 9-250 Mlni Drill Sleeve Drill Bit 1.1 and 1.5 mm \varnothing
- 9-253 Mlni Drill Sleeve Drill Bit 1.5 and 2.0 mm \varnothing



- 9-252 Drill Guide and Drill Sleeve, 2.0 mm \varnothing
with 3 and 1 hole respectively
Drill Bit 2.0 mm \varnothing



- 9-254 Tap Sleeve 3.5 mm \varnothing
Drill Sleeve 2.5 mm \varnothing
for Drill Bit and Tap for 3.5 mm Cortex Screws
with fine thread
- 9-255 Tap Sleeve 2.7 mm \varnothing
Drill Sleeve 2.0 mm \varnothing
for Drill Bit and Tap for 3.5 mm Cortex Screws
with fine thread



- 9-256 Tap Sleeve 3.5 mm \varnothing
for Taps 3.5 and 2.7 mm \varnothing
May also be used as a Guide
for 3.2 mm \varnothing Drill Bits



- 9-258 Pointed Drill Guide



TREU = INSTRUMENTE

Instruments for Screw Fixation



- 9-260** Tap Sleeve 4.5 mm \varnothing
For Taps 6.5 mm \varnothing
May also be used as Drill Guide for
4.5 mm Drill Bits
The notched tip prevents slipping on the bone
Use Sleeve 8 mm \varnothing in the screw holes of plates



- 9-262** Drill Guides for Round-Hole Plates
for Drill Bit 3.2 mm \varnothing
Standard, 40 mm



- 9-266** Neutral and Load Drill Guide, 2.0 mm
For 2.0 mm screws
Use Drill Bit 1.5 mm \varnothing

- 9-268** Neutral and Load Drill Guide, 2.7 mm
For 2.7 mm screws
Use Drill Bit 2.0 mm \varnothing

- 9-270** Neutral and Load Drill Guide, 3.5 / 1.25 mm
For 3.5 mm Cortex Screws with fine thread
Use Drill Bit 2.5 mm \varnothing

- 9-272** Neutral and Load Drill Guide, 4.5 mm
For 4.5 mm screws
Use Drill Bit 3.2 mm \varnothing



- 9-276** Insert Drill Sleeve 2.7 / 2.0 mm \varnothing
For 2.7 mm Cortex Lag Screws
Drill Bit 2.0 mm \varnothing

- 9-278** Insert Drill Sleeve 3.5 / 2.5 mm \varnothing
For 3.5 mm Cortex Lag Screws
Drill Bit 2.5 mm \varnothing

- 9-280** Insert Drill Sleeve 4.5 / 3.2 mm \varnothing
For 3.5 mm Cortex Lag Screws with fine thread
Drill Bit 3.2 mm \varnothing



- 9-284** C-Clamp Drill Guide with thread
for Drill Bit 4.5 mm \varnothing



TREU = INSTRUMENTE

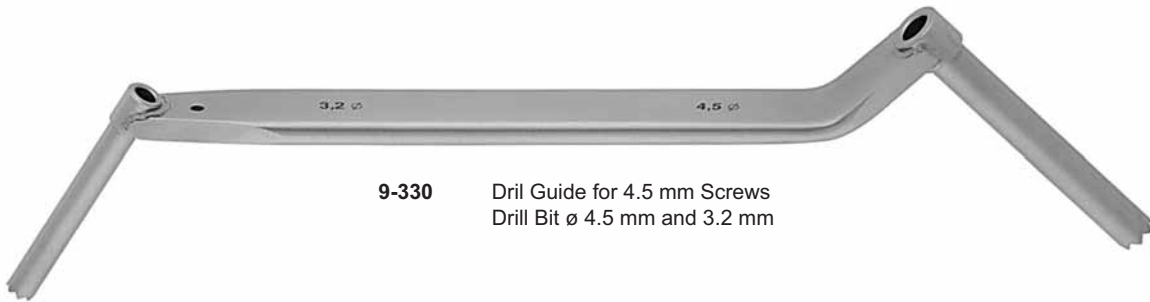

9-330 Drill Guide for 4.5 mm Screws
Drill Bit \varnothing 4.5 mm and 3.2 mm

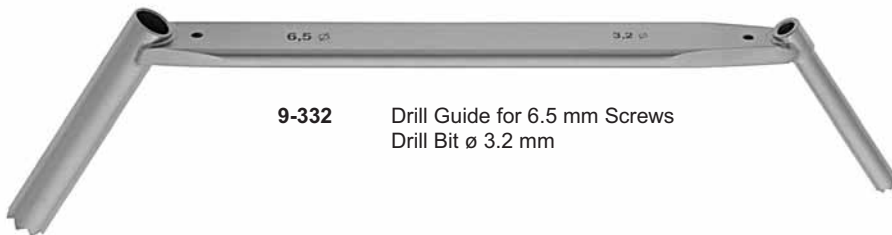

9-332 Drill Guide for 6.5 mm Screws
Drill Bit \varnothing 3.2 mm

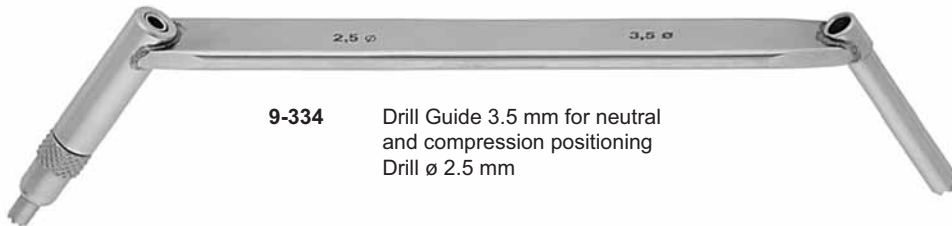

9-334 Drill Guide 3.5 mm for neutral
and compression positioning
Drill \varnothing 2.5 mm

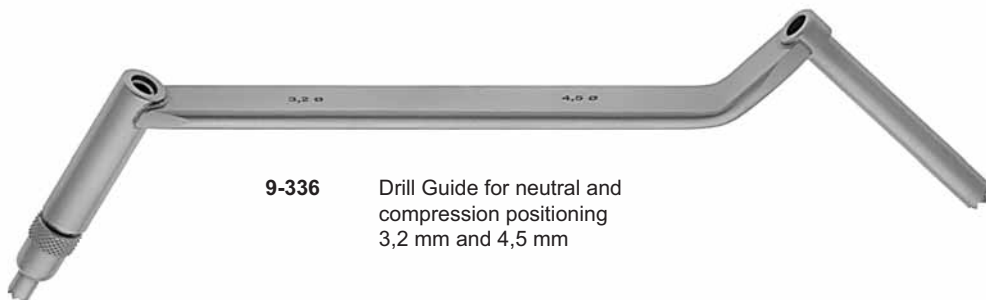

9-336 Drill Guide for neutral and
compression positioning
3,2 mm and 4,5 mm



9-338 Drill Guide 4.5 / 3.2
with 2 Inserts



TREU = INSTRUMENTE

Bending Instruments for Plates



9-400 Bending Iron for Mini and Finger Plates



9-402 Bending Iron for 3.5 mm Reconstruction Plates



9-404 Bending Iron for 2.7 mm Reconstruction Plates



9-406 Bending Pliers for 1.5 and 2.0 mm Plates



9-408 Bending Pliers for 2.7 and 3.5 mm Plates, 24,0 cm

9-409 Bending Pliers for 1.0 and 2.0 mm Plates, 20,0 cm



9-410 Bending Pliers



TREU - INSTRUMENTE

Bending Instruments for Plates

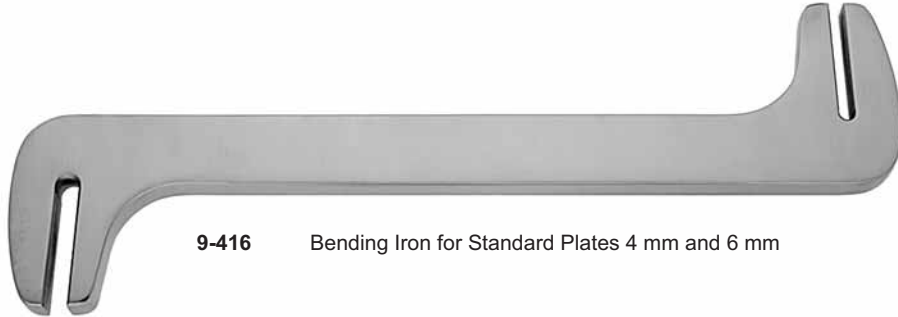

9-416 Bending Iron for Standard Plates 4 mm and 6 mm



9-418 Bending Pliers for Straight Plates



9-420 Plate Bending Press



TREU = INSTRUMENTE

Instruments for Plates



9-430 Drill Sleeve for Tension Device for Drill Bit 3.2 mm \varnothing

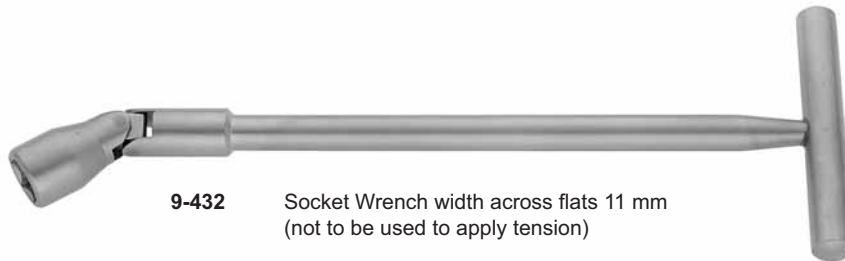

9-432 Socket Wrench width across flats 11 mm
(not to be used to apply tension)



9-436 8 mm screw-type
Compression Device



9-438 Combination Wrench
width across flats 11 mm
for Tension Device, External Fixator
Medullary Nailing Instruments, etc.



9-440 Articulated Tension Device
with Indicator, span 20 mm
May also be used for distraction
of Standard and Small Plates



9-442 Pin Wrench for Tension Device and Distractor



TREU = INSTRUMENTE

General Instruments Set

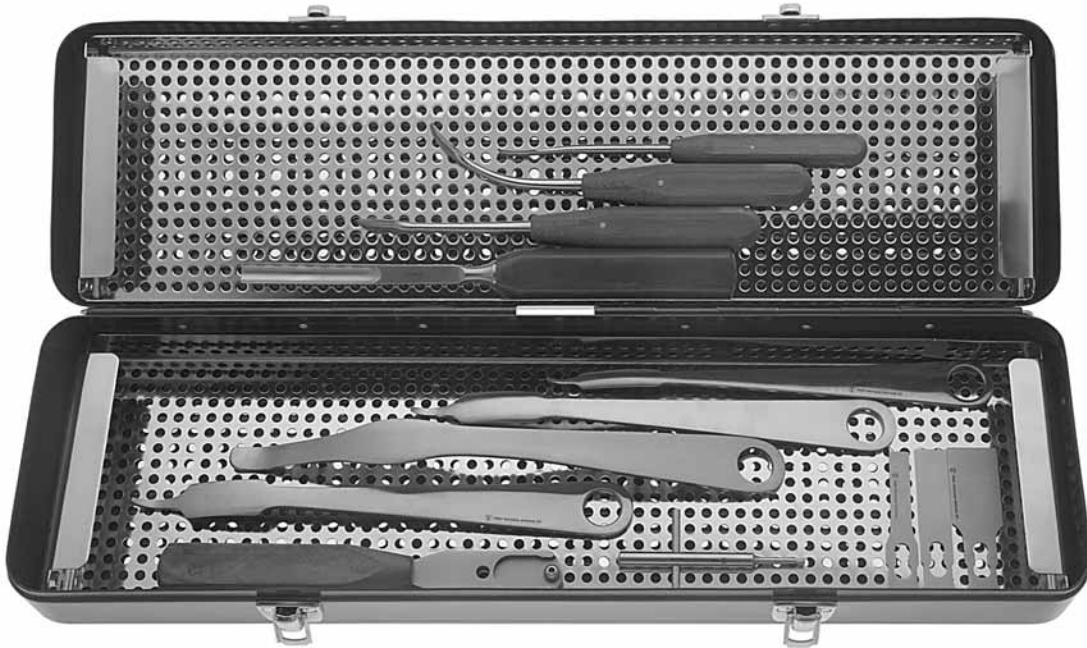

- T 910** General Instruments Set
- T 111** Aluminium Case
- T 112** Upper Tray
- T 112** Lower Tray

Hohmann Retractors

- 9-656** Blade width 8 mm, short narrow tip
- 9-658** Blade width 18 mm, short narrow tip
- 9-660** Blade width 18 mm, long narrow tip for hip surgery
- 9-676** Blade width 24 mm, long wide tip for hip surgery
- 9-776** Wrench for Chisel Handle

Periosteal Elevators

- 9-750** Medium, straight blade, straight edge, width 14 mm
- 9-752** Medium, curved blade, round edge, width 14 mm
- 9-756** Small, curved blade, round edge, width 6 mm

- 9-704** Hammer, 500 g
- 9-766** Chisel Handle, synthetic, autoclavable

Chisel Blades

- 9-768-** 1 ea: 10, 16 and 25 mm
- 9-772**

- 9-792** Gouge, straight, width 10 mm for Cancellous Bone Grafts



TREU = INSTRUMENTE

Standard Bone Forceps Set

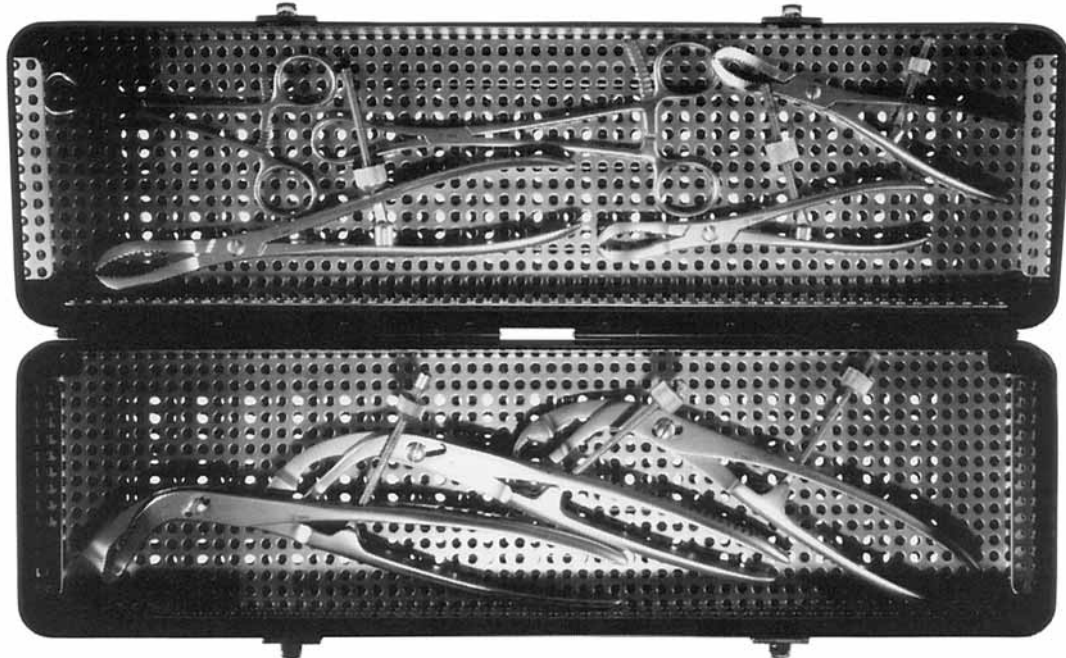

- T 920** Standard Bone Forceps Set
- T 111** Aluminium Case
- T 112** Upper Tray
- T 112** Lower Tray

- 9-584** Self-Centering Bone Holding Forceps, size 1, 240 mm long
- 9-586** Self-Centering Bone Holding Forceps, size 2, 260 mm long
- 9-588** Self-Centering Bone Holding Forceps, size 3, 280 mm long
- 9-560** Reduction Forceps, large, 240 mm long
- 9-562** Reduction Forceps, small, 160 mm long
- 9-604** Reduction Forceps with point, 200 mm long



TREU - INSTRUMENTE



- 9-500** Kern Baby Bone Holding Forceps 160 mm with ratchet
- 9-502** Kern Baby Bone Holding Forceps 160 mm without ratchet
- 9-504** Kern Bone Holding Forceps 210 mm with ratchet
- 9-506** Kern Bone Holding Forceps 210 mm without ratchet

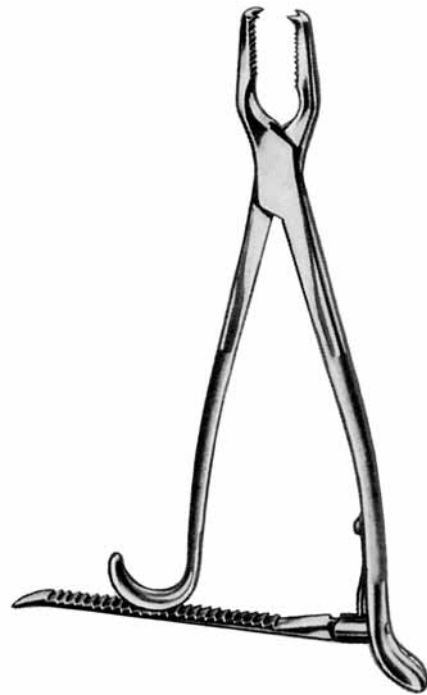

- 9-508** Lane Bone Holding Forceps 330 mm with ratchet
- 9-510** Lane Bone Holding Forceps 330 mm without ratchet
- 9-512** Lane Bone Holding Forceps 450 mm without ratchet



- 9-520** Farabeuf-Lambotte Bone Holding Forceps 260 mm with ratchet
- 9-522** Farabeuf-Lambotte Bone Holding Forceps 260 mm without ratchet



- 9-530** Lambotte Bone Holding Forceps 220 mm
- 9-532** Lambotte Bone Holding Forceps 270 mm
- 9-534** Lambotte Bone Holding Forceps 330 mm



TREU = INSTRUMENTE



9-540 Verbrügge Bone Holding Forceps 175 mm



9-544 Verbrügge Bone Holding Forceps 250 mm
9-546 Verbrügge Bone Holding Forceps 260 mm
9-548 Verbrügge Bone Holding Forceps 270 mm



TREU = INSTRUMENTE



9-560 Reduction Forceps with Thread Lock 240 mm



9-562 Reduction Forceps with Thread Lock 160 mm



9-570 Ferguson Bone Holding Forceps 230 mm



TREU = INSTRUMENTE



Self-Centering Bone Holding Forceps with Thread Lock

- 9-580** For Small Fragments 150 mm, jaw 9 mm
- 9-582** Size 0
190 mm, extra small jaw 10 mm
- 9-584** Size 1
240mm, small jaw 14 mm
- 9-586** Size 2
260 mm, medium jaw 18 mm
- 9-588** Size 3
280 mm, large jaw 23 mm



9-590 Lewin 190 mm



9-592 Semb 200 mm
9-594 Semb 200 mm with ratchet



9-596 Reposition Forceps
for Small Fragments 135 mm
9-597 Reposition Forceps
for Small Fragments 105 mm



TREU = INSTRUMENTE



9-600
Forceps with Ratchet
Fixation 145 mm



9-602
Reil 170 mm

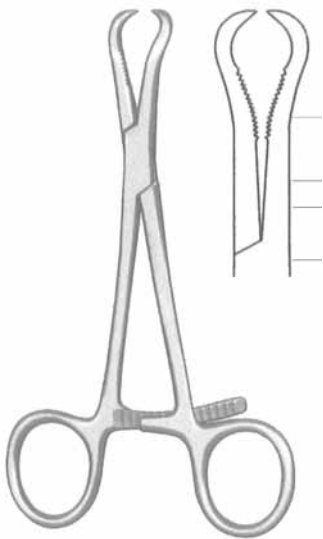

9-629
Bone Reduction Forceps
curved with serrations and pointed tips 14,0 cm



9-604
Reduction Forceps
with points 200 mm

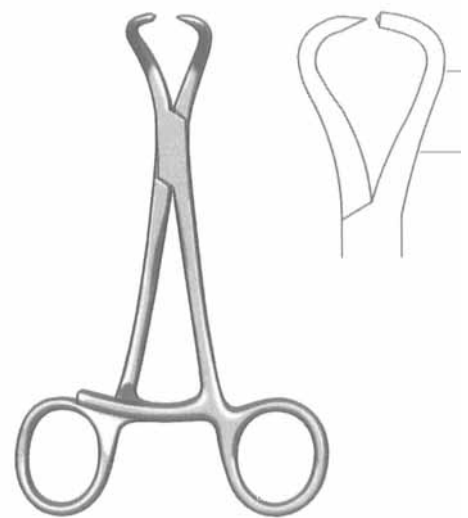

9-603
Bone Reduction Forceps
curved one point tip one step-pointed tip 13,0 cm



TREU - INSTRUMENTE



9-620
200 mm



9-622
Malleolar Forceps



9-624
For fingers, with Drill
Guide for Klrschner
Wires up to \varnothing 1 mm 170 mm



9-630
Holding Forceps for Mini 135 mm



TREU - INSTRUMENTE



Lowmann Bone Clamp
1x2 jaws

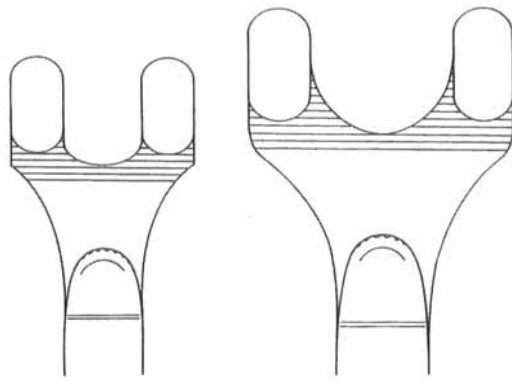

9-610
130 mm

9-614
200 mm



Lambert-Lowmann
Bone Clamp 2x2 jaws

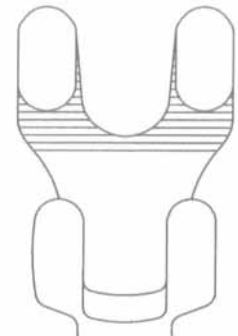

9-615
185 mm

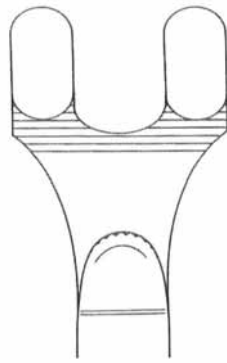

9-612
185 mm

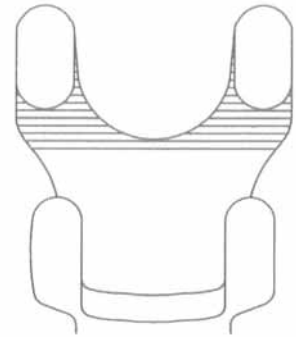

9-616
200 mm



Lowmann Bone Clamp
1x1 jaws

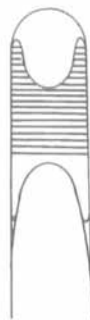

9-621
120 mm

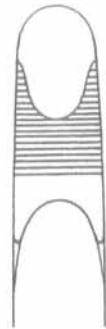

9-623
185 mm

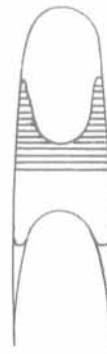

9-625
200 mm



TREU - INSTRUMENTE



9-632 Ulrich 230 mm
9-634 Ulrich 250 mm
9-636 Ulrich 280 mm
9-638 Mini 190 mm



9-640 Ulrich 260 mm



9-631 Hey Groves 210 mm
9-633 270 mm
9-635 305 mm



9-639 Ulrich 185 mm
9-643 Ulrich 280 mm

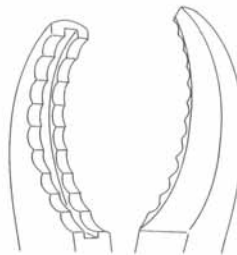



TREU = INSTRUMENTE

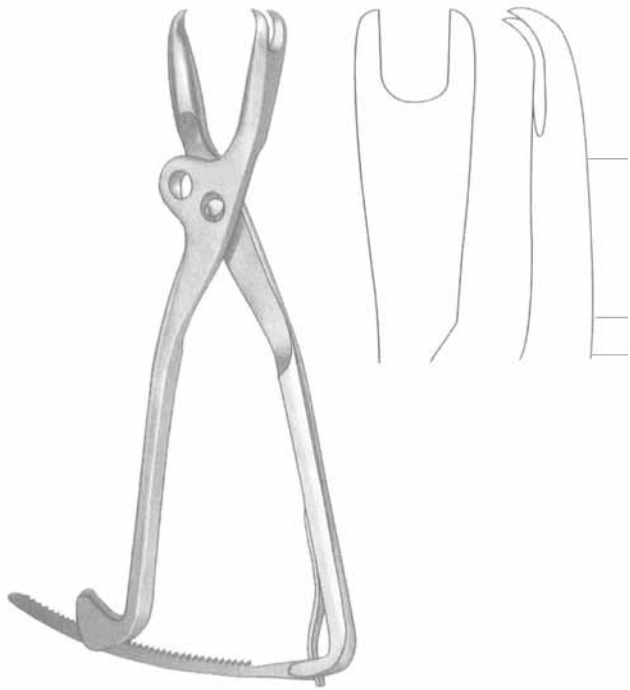

9-641
Bishop Bone Forceps
adjustable jaw with ratchet
23,0 cm



9-627
Patella Forceps
with speedlock
2x2 sharp teeth
18,0 cm

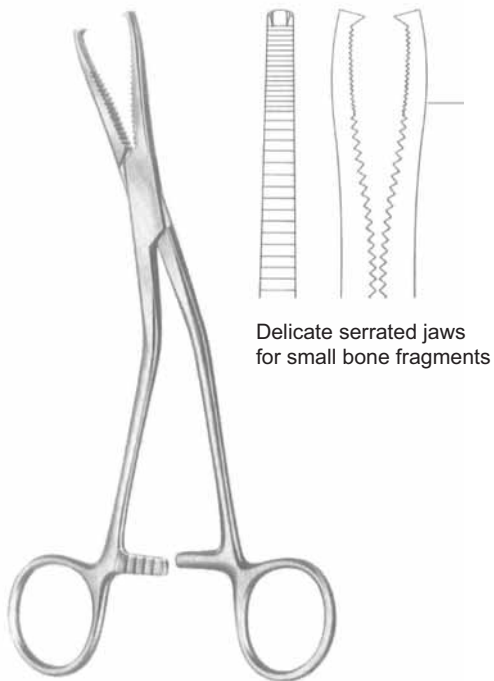

Delicate serrated jaws
for small bone fragments

9-645
Dingman Forceps
angular serrated jaws
2x2 sharp teeth 19,0 cm

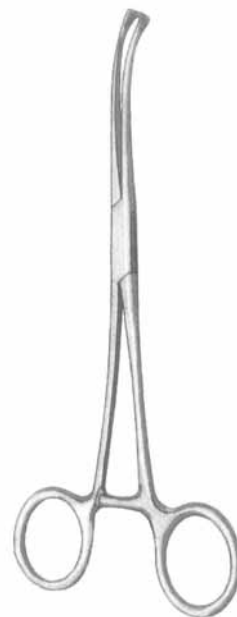

9-637
Sesamoidectomy Clamp
17,0 cm



TREU = INSTRUMENTE



9-646 Holding Forceps with ball



9-618 Reposition Forceps 230 mm

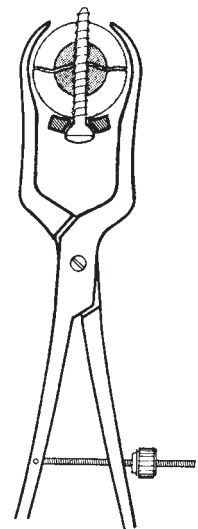
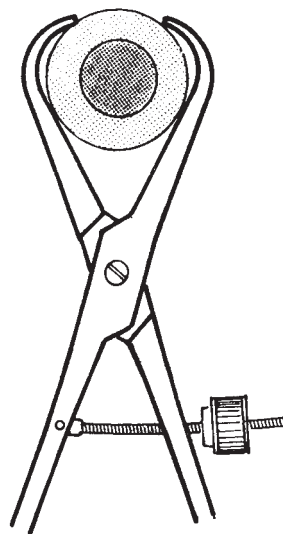



TREU = INSTRUMENTE

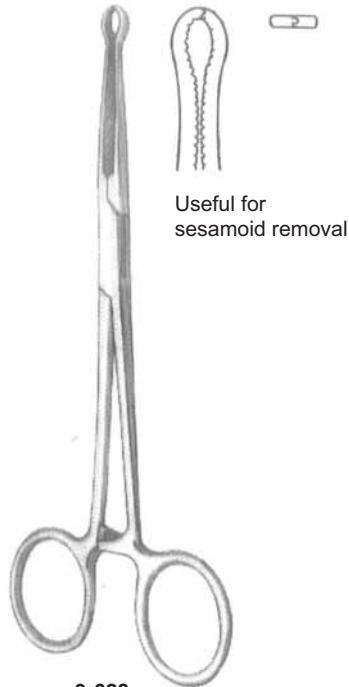

Useful for
sesamoid removal

9-628
Locke Phalangeal
serrated jaws with 1x2 teeth
15,0 cm

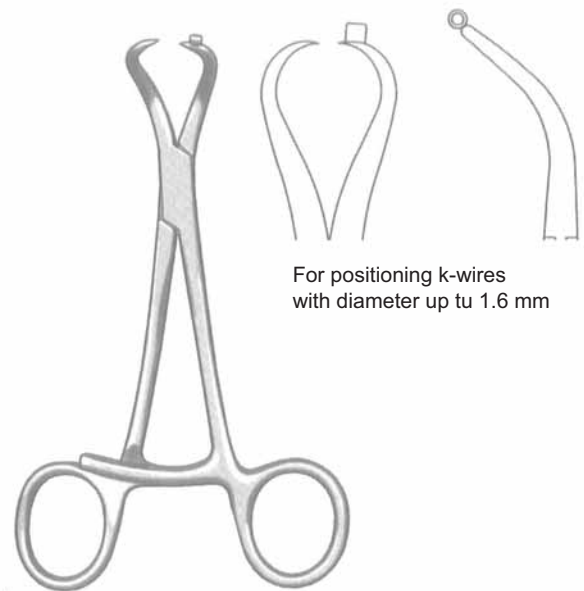

For positioning k-wires
with diameter up to 1.6 mm

9-672
Bone Reduction Forceps curved
with guide 13,0 cm

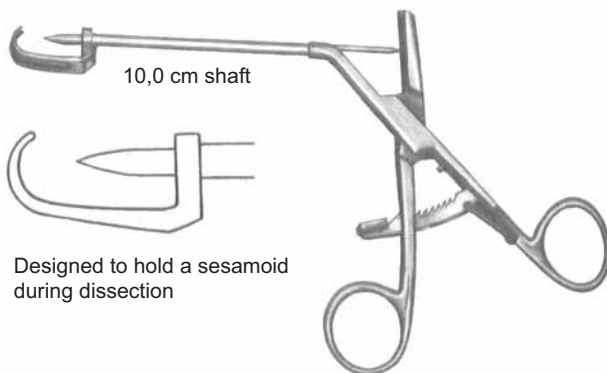

10,0 cm shaft

Designed to hold a sesamoid
during dissection

9-675
Vogen Sesamoid Clamp

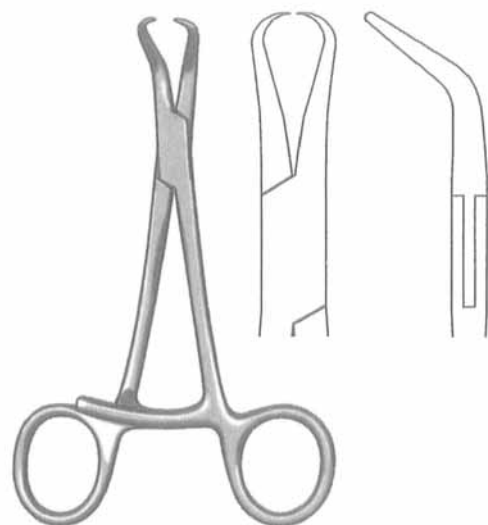

9-677
Stagbeetle Forceps
curved pointed tips
12,0 cm



TREU - INSTRUMENTE

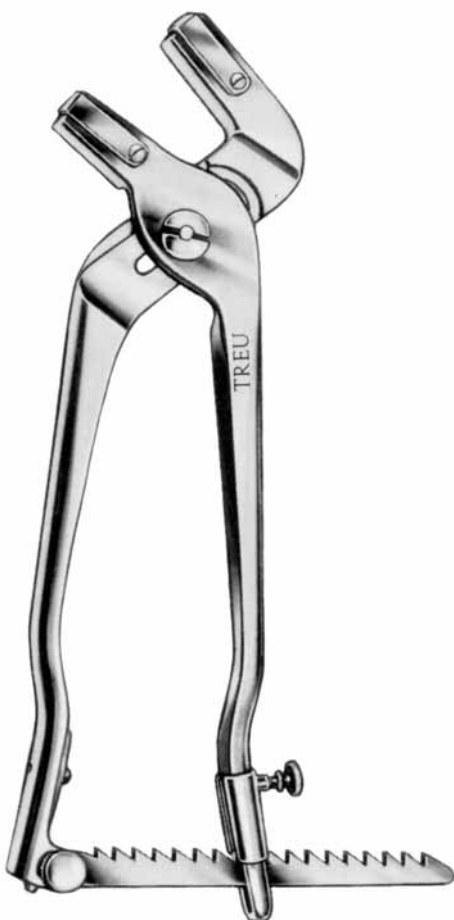

Set includes:
Hooked Jaws: 1 pair
Serrated Jaws: 3 pairs
Sizes: 32, 51 and 57 mm

9-644 Charnley Bone Forceps



TREU = INSTRUMENTE

Standard Retractors



9-650
Small, width 6 mm
short, narrow tip



9-652
Small, width 8 mm
short, narrow tip



9-654
For Small Fragments
with broad shank



9-656
Width 8 mm
short, narrow tip



9-658 width 18 mm short, narrow tip
9-660 width 18 mm long, narrow tip



9-662
Humeral Head Retractor
18 mm blade width



9-666
width 43 mm narrow tip
9-668
width 70 mm narrow tip



9-670
width 43 mm
long shank, angled



TREU = INSTRUMENTE



9-674
width 22 mm
wide tip



9-676
long wide tip for Hip
Surgery, width 24 mm



9-678
Bennett 240 mm



9-680
Lange-Hohmann



9-682
Retractor for Knee
Blount 270 mm



9-684
Retractor for
Knee 175 mm



TREU = INSTRUMENTE

Shoulder Retractors



9-691
9-692

Fukuda Style Retractor with T-Handle
32 x 81 mm blade
38 x 81 mm blade

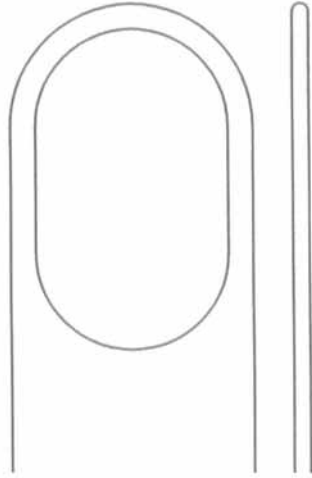

9-693
Pelvic Retractor Blunt 27,0 cm
24 mm blade



9-695
Bristow / Bankart Soft Tissue Retractor
19,0 cm blunt prongs

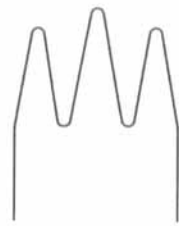

21 mm blade



9-690
Capsule Retractor 25, 0 cm
3 sharp prongs

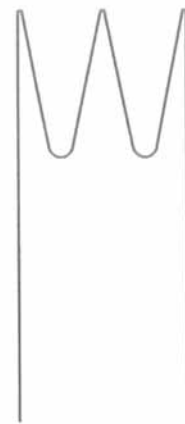

22 mm blade



TREU = INSTRUMENTE



42.360.04
Ollier Retractor
4 blunt prongs 23,0 cm



42.364.40
Israel Retractor
blunt prongs 25,0 cm



9-689
Bristow / Bankart Humeral Retractor
2 blunt prongs



TREU = INSTRUMENTE

Bone Hammers

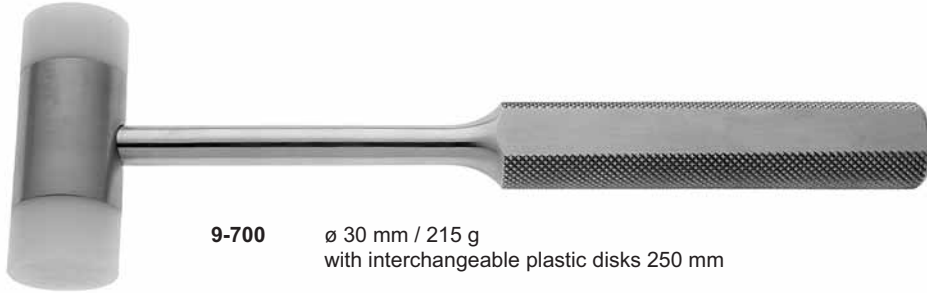

9-700 \varnothing 30 mm / 215 g
with interchangeable plastic disks 250 mm

9-701 Pair of spare disks



9-702 Weight approx: 350 g
9-704 Weight approx: 500 g (Standard size)
9-706 Weight approx: 700 g (For Medullary Nailing)



9-708 \varnothing 42 mm, 250 mm
Material Ferrozell can be sterilized in an autoclave at 3 bar overpressure (143° C)



9-710 18,0 cm length, \varnothing 30 mm, 125 g (4 oz)
Material Ferrozell can be sterilized in an autoclave at 3 bar overpressure (143° C)



TREU - INSTRUMENTE

Bone Hammers

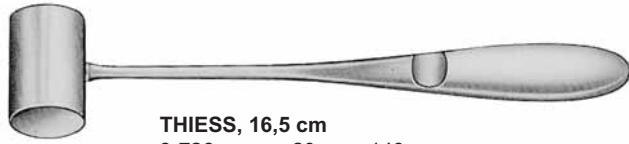

THIESS, 16,5 cm
9-726 \varnothing 20 mm, 140 gr.
 lead filled

9-728 \varnothing 20 mm, 140 gr.
 brass, solid

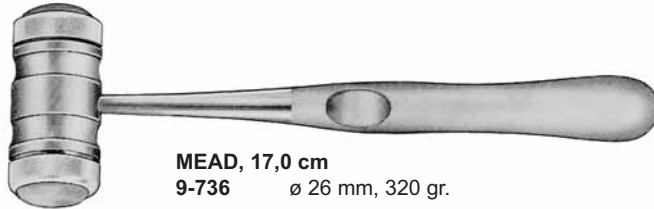

MEAD, 17,0 cm
9-736 \varnothing 26 mm, 320 gr.

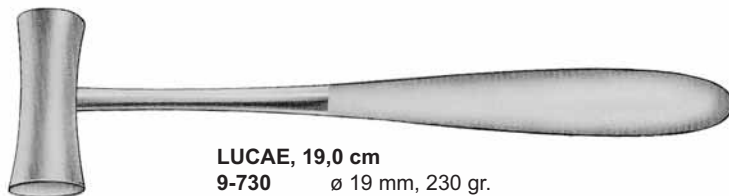

LUCAE, 19,0 cm
9-730 \varnothing 19 mm, 230 gr.

9-732 \varnothing 25 mm, 260 gr.



PARTSCH, 18,0 cm
9-734 \varnothing 22 mm, 200 gr.



TREU = INSTRUMENTE

Bone Hammers



9-735
Narrow Tip Mallet
phenolic handle 150 gr.
20,0 cm



9-738
Ortho Short Mallet
stainless steel 240 gr.
18,0 cm



9-740
Cloward-style Mallet
stainless steel 120 gr.
19,0 cm



WILLIGER, 24,0 cm
9-712 \varnothing 26 mm, 300 gr.
9-714 \varnothing 28 mm, 340 gr.
9-716 \varnothing 30 mm, 400 gr.

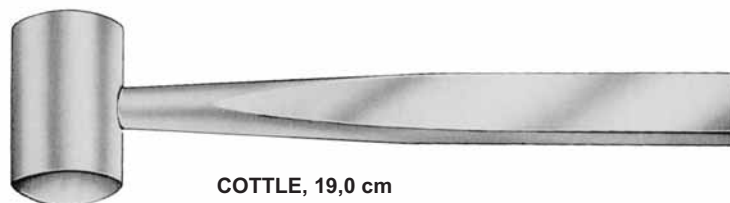

COTTLE, 19,0 cm
9-717 240 gr.



TREU = INSTRUMENTE

Periosteal Elevators

with synthetic handle, autoclavable



9-750
Medium straight blade
round edge, width 14 mm
20,0 cm



9-752
medium curved blade
round edge, width 14 mm
20,0 cm



9-754
large straight blade
round edge, width 30 mm
20,0 cm



9-756
Small curved blade
round edge, width 6 mm



9-758
Small curved blade
straight edge, width 6 mm



9-760
Extra small curved blade
straight edge, width 3 mm



TREU = INSTRUMENTE



9-766 Chisel Handle



- 9-768** Chisel Blade 10 mm
- 9-770** Chisel Blade 16 mm
- 9-772** Chisel Blade 25 mm
- 9-774** Chisel Blade 5 mm



9-776 Wrench for Chisel Handle



- | | | |
|--------------|----------|--|
| | straight | |
| 9-790 | 5 mm | |
| 9-792 | 10 mm | |
| 9-794 | 15 mm | |
| | 25,0 cm | |



- | | | |
|--------------|---------|--|
| | curved | |
| 9-796 | 5 mm | |
| 9-798 | 10 mm | |
| 9-800 | 15 mm | |
| | 25,0 cm | |



- | | | |
|--------------|---------|--|
| | flat | |
| 9-802 | 10 mm | |
| 9-804 | 15 mm | |
| 9-806 | 20 mm | |
| 9-808 | 25 mm | |
| | 22,0 cm | |



- | | | |
|--------------|---------|--|
| | hollow | |
| 9-814 | 10 mm | |
| 9-816 | 15 mm | |
| 9-818 | 20 mm | |
| 9-820 | 25 mm | |
| | 22,0 cm | |



TREU = INSTRUMENTE

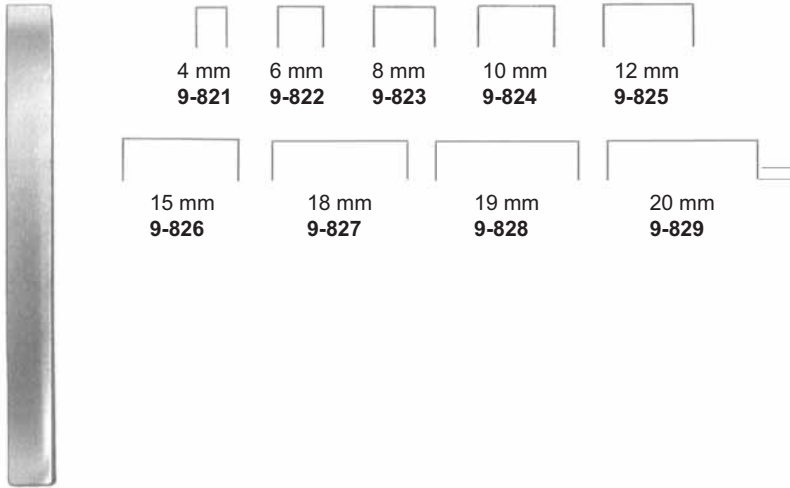

Mini Lambotte Chisel
12,5 cm

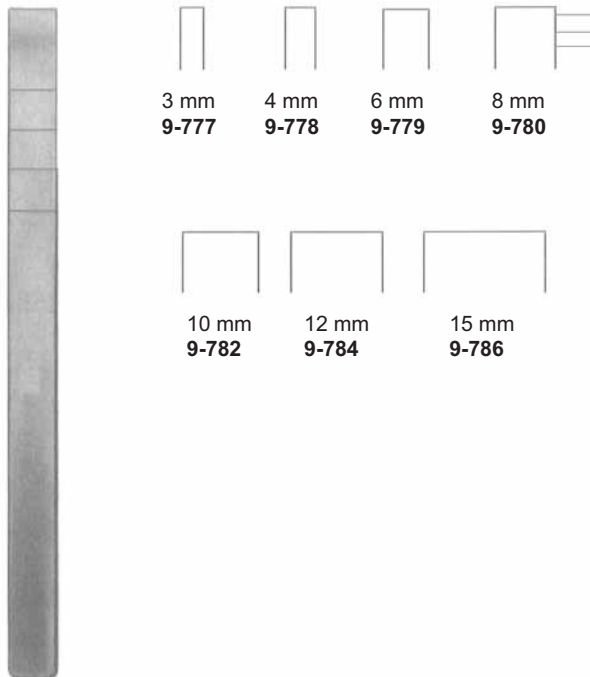

Lambotte Osteotome
straight 17,0 cm



TREU = INSTRUMENTE



23,0 cm

- 9-919** Lambotte 6 mm
- 9-920** Lambotte 10 mm
- 9-922** Lambotte 12 mm
- 9-924** Lambotte 15 mm
- 9-926** Lambotte 20 mm
- 9-928** Lambotte 25 mm
- 9-930** Lambotte 30 mm
- 9-932** Lambotte 38 mm
- 9-934** Lambotte 44 mm
- 9-936** Lambotte 50 mm







23,0 cm

- 9-937** Lambotte curved 6 mm
- 9-938** Lambotte curved 10 mm
- 9-940** Lambotte curved 12 mm
- 9-942** Lambotte curved 15 mm
- 9-944** Lambotte curved 20 mm
- 9-946** Lambotte curved 25 mm
- 9-948** Lambotte curved 30 mm
- 9-950** Lambotte curved 38 mm
- 9-952** Lambotte curved 44 mm
- 9-954** Lambotte curved 50 mm



Lexer-Mini Chisel
18,0 cm

- 
4 mm
9-960
- 
6 mm
9-961
- 
8 mm
9-962
- 
10 mm
9-965
- 
12 mm
9-967



TREU - INSTRUMENTE

Bone Surgery Bone Chisel and Gouges



20,0 cm

- 9-830** Smith Peterson 6 mm
- 9-832** Smith Peterson 9 mm
- 9-834** Smith Peterson 12 mm
- 9-836** Smith Peterson 15 mm
- 9-838** Smith Peterson 20 mm
- 9-840** Smith Peterson 25 mm
- 9-842** Smith Peterson 30 mm



20,0 cm

- 9-844** Smith Peterson curved 6 mm
- 9-846** Smith Peterson curved 9 mm
- 9-848** Smith Peterson curved 12 mm
- 9-850** Smith Peterson curved 15 mm
- 9-852** Smith Peterson curved 20 mm
- 9-854** Smith Peterson curved 25 mm
- 9-856** Smith Peterson curved 30 mm



20,0 cm

- 9-858** Smith Peterson Gouge 6 mm
- 9-860** Smith Peterson Gouge 9 mm
- 9-862** Smith Peterson Gouge 12 mm
- 9-864** Smith Peterson Gouge 15 mm
- 9-866** Smith Peterson Gouge 20 mm
- 9-868** Smith Peterson Gouge 25 mm
- 9-870** Smith Peterson Gouge 30 mm



20,0 cm

- 9-872** Smith Peterson curved Gouge 6 mm
- 9-874** Smith Peterson curved Gouge 9 mm
- 9-876** Smith Peterson curved Gouge 12 mm
- 9-878** Smith Peterson curved Gouge 15 mm
- 9-880** Smith Peterson curved Gouge 20 mm
- 9-882** Smith Peterson curved Gouge 25 mm
- 9-884** Smith Peterson curved Gouge 30 mm



TREU = INSTRUMENTE

Chisels, Gouges and Osteotomes



- 9-900** Stille 10 mm
- 9-902** Stille 12 mm
- 9-904** Stille 15 mm
- 9-906** Stille 20 mm
- 9-908** Stille 25 mm

20,0 cm



- 9-910** Stille Gouge 10 mm
- 9-912** Stille Gouge 12 mm
- 9-914** Stille Gouge 15 mm
- 9-916** Stille Gouge 20 mm
- 9-918** Stille Gouge 25 mm

20,0 cm



ALEXANDER, 18,0 cm

- 16-370** 4 mm
- 16-372** 6 mm
- 16-374** 8 mm
- 16-376** 10 mm
- 16-378** 12 mm
- 16-380** 14 mm



ALEXANDER, 18,0 cm

- 16-382** 4 mm
- 16-384** 6 mm
- 16-386** 8 mm
- 16-388** 10 mm
- 16-390** 12 mm
- 16-392** 14 mm



PARTSCH, 17,0 cm

- 16-414** 2 mm
- 16-416** 3 mm
- 16-418** 4 mm
- 16-420** 5 mm
- 16-422** 6 mm
- 16-424** 7 mm
- 16-426** 8 mm



PARTSCH, 17,0 cm

- 16-442** 2 mm
- 16-444** 3 mm
- 16-446** 4 mm
- 16-448** 5 mm
- 16-450** 6 mm
- 16-452** 7 mm
- 16-454** 8 mm



TREU - INSTRUMENTE

Chisels, Gouges and Osteotomes

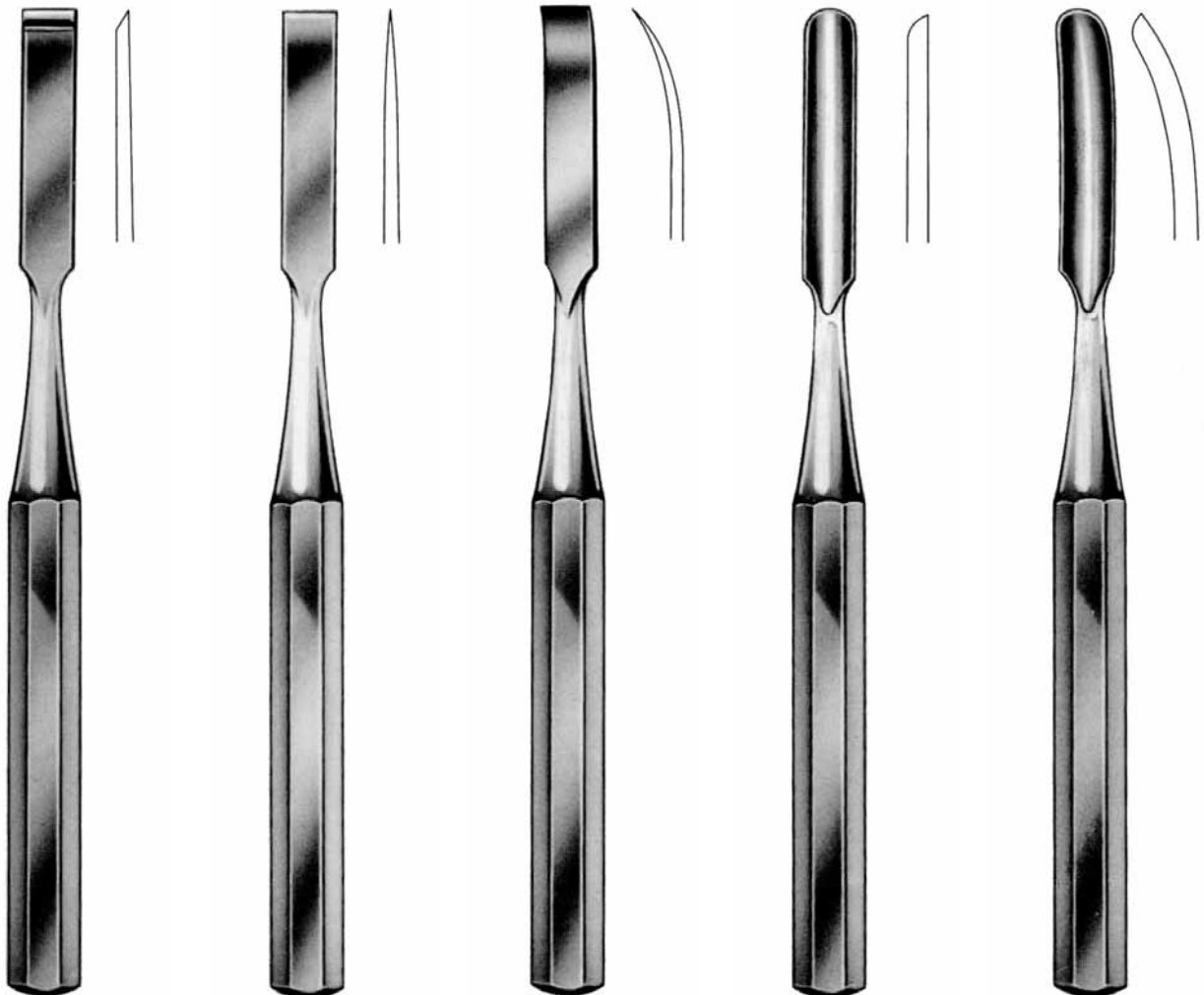

HIBBS, 24,0 cm

16-310	6 mm	16-320	6 mm	16-330	6 mm	16-340	6 mm	16-350	6 mm
16-312	13 mm	16-322	13 mm	16-332	13 mm	16-342	13 mm	16-352	13 mm
16-314	19 mm	16-324	19 mm	16-334	19 mm	16-344	19 mm	16-354	19 mm
16-316	25 mm	16-326	25 mm	16-336	25 mm	16-346	25 mm	16-356	25 mm
16-318	32 mm	16-328	32 mm	16-338	32 mm	16-348	32 mm	16-358	32 mm



TREU - INSTRUMENTE

Chisels, Gouges and Osteotomes



13,5 cm

16-250	8 mm
16-252	10 mm
16-254	12 mm
16-256	14 mm
16-258	16 mm



13,5 cm

16-260	8 mm
16-262	10 mm
16-264	12 mm
16-266	14 mm
16-268	16 mm



13,5 cm

16-270	8 mm
16-272	10 mm
16-274	12 mm
16-276	14 mm
16-278	16 mm



HOKE, 13,5 cm

16-286	3 mm
16-288	5 mm
16-290	6 mm
16-292	8 mm
16-294	9 mm



LUCAS, 16,0 cm

16-296	4 mm
16-298	6 mm



LUCAS, 16,0 cm

16-300	3 mm
16-302	5 mm



TREU = INSTRUMENTE

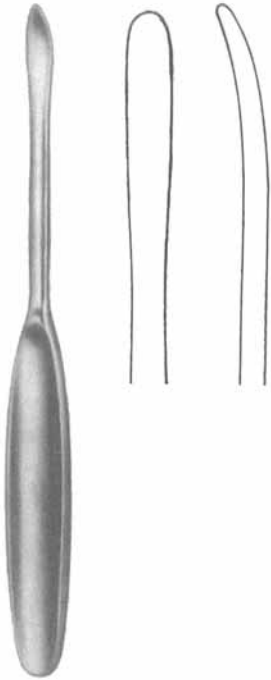

9-978
Lane Elevator
blunt 10 mm blade
20,0 cm

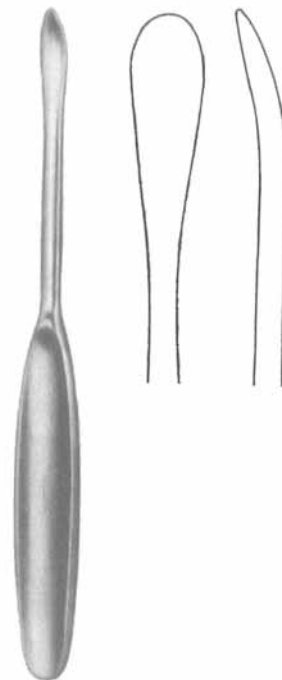

9-979
Lane Elevator
blunt 6 mm blade
20,0 cm

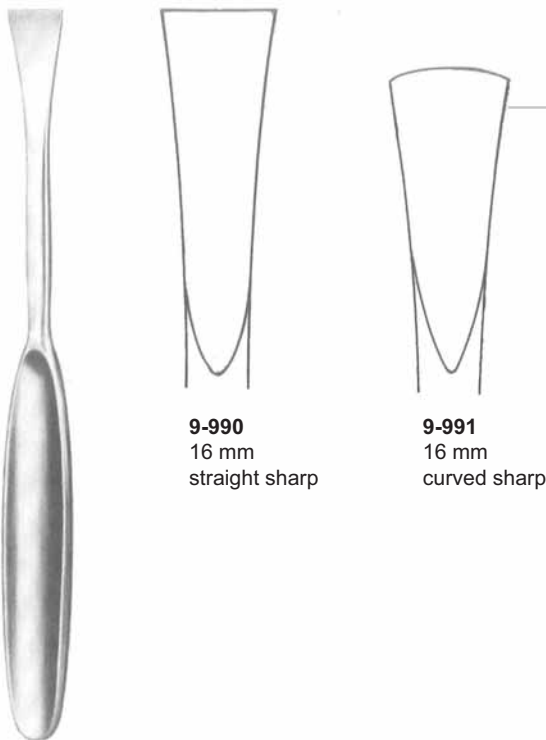

9-990
16 mm
straight sharp



9-991
16 mm
curved sharp

Cushing Elevator
19,0 cm



9-968 Farabeuf



9-970 Farabeuf



TREU - INSTRUMENTE

Peristéal Raspatories, Bone Curettes



9-980 Lambotte 10 mm
9-982 Lambotte 15 mm
9-984 Lambotte 20 mm



Spratt
17,0 cm

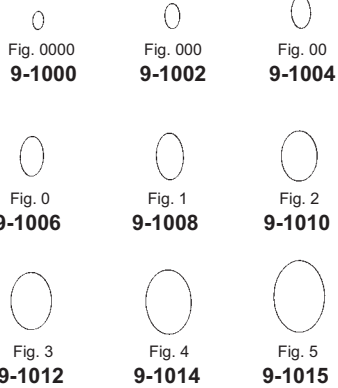

Bruns
17,0 cm

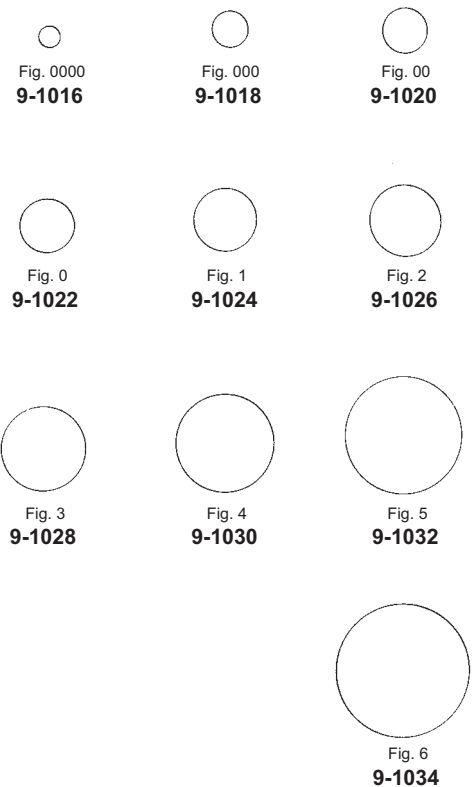



TREU = INSTRUMENTE

Bone Curettes



Bruns 230 mm

-  9-1040
-  9-1042
-  9-1044
-  9-1046
-  9-1048







-  9-1050
-  9-1052
-  9-1054
-  9-1056



9-1060 250 mm



Simon 240 mm

-  9-1062
-  9-1064
-  9-1066
-  9-1068
-  9-1070
-  9-1072



TREU = INSTRUMENTE

Amputation Retractor and Saws

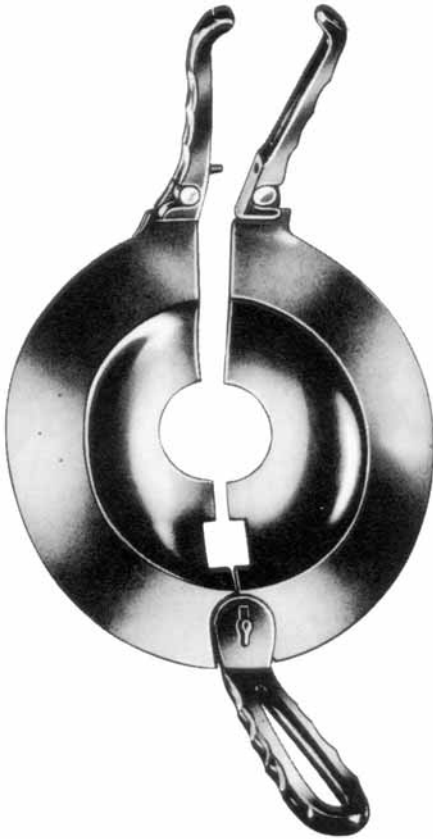

9-1280 Percy Retractor



9-1282 Charrière 27 cm
9-1284 Charrière 30 cm

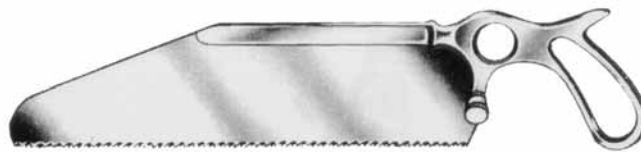

9-1286 Satterlee 31 cm



9-1290 Charrière 35 cm



TREU = INSTRUMENTE

Bone Cutting Forceps



Liston Bone Cutting Forceps
9-1300 140 mm straight
9-1302 140 mm curved
9-1304 170 mm straight
9-1306 170 mm curved
9-1308 190 mm straight
9-1310 190 mm curved
9-1312 220 mm straight
9-1314 220 mm curved



9-1320 Ruskin-Liston 190 mm straight
9-1322 Ruskin-Liston 190 mm curved



9-1330 Stille-Liston 270 mm straight
9-1332 Stille-Liston 270 mm curved



9-1336 Stille Horsley 270 mm



9-1340 Stille Semb 250 mm



9-1346 Böhler 150 mm straight
9-1348 Böhler 150 mm curved



TREU = INSTRUMENTE

Bone Rongeur Forceps

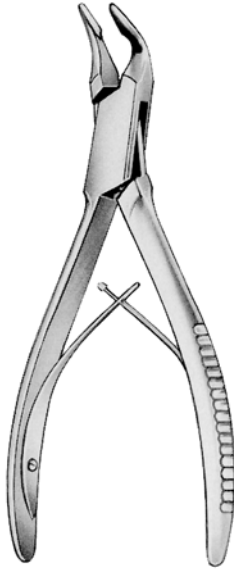

BLUMENTHAL
15,5 cm



9-1407
4 x 11



9-1406
4 x 11



9-1405
4 x 11



MINI-FRIEDMAN
9-1402
12,0 cm



FRIEDMAN
9-1404
14,0 cm



9-1384 Luer 170 mm straight
9-1386 Luer 170 mm curved



9-1388 Lempert 190 mm straight
9-1390 Lempert 190 mm curved

9-1392 Lempert 160 mm straight
9-1394 Lempert 160 mm curved



TREU - INSTRUMENTE

Bone Rongeurs



BÖHLER
15,0 cm



9-1376



9-1377

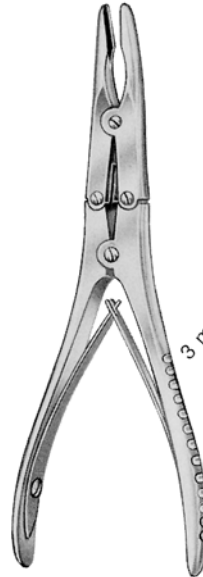

KLEINERT-KUTZ
15,0 cm



9-1373



9-1378

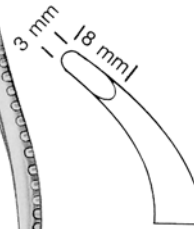

9-1374



RUSKIN-MINI
9-1375
15,0 cm



BEYER
9-1380
18,0 cm



ZAUFAL-JANSEN
9-1372
18,0 cm

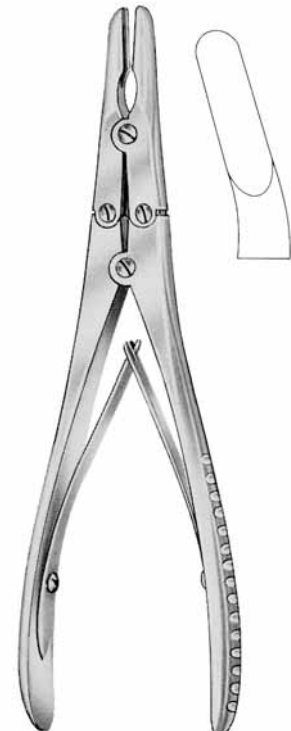

RUSKIN
9-1368
18,0 cm





TREU = INSTRUMENTE

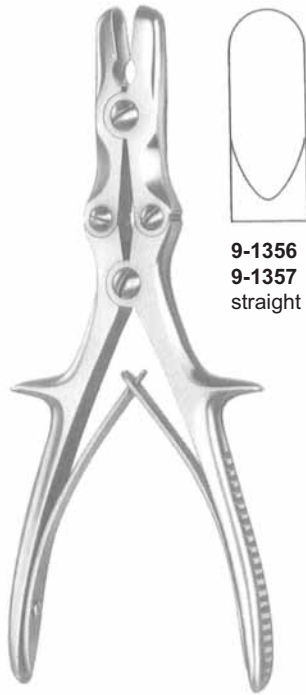

Stille-Luer Rongeur
10 x 18 mm bite



9-1356 23,0 cm
9-1357 26,0 cm
straight



9-1358 23,0 cm
9-1359 26,0 cm
curved



9-1350
Stille
angled
23,0 cm



Echlin Duckbill Rongeur
curved on side
straight bite



2 x 10 mm
9-1396



3 x 10 mm
9-1398



4 x 10 mm
9-1400



9-1418
Frykholm Rongeur
curved 4 x 14 mm bite





TREU = INSTRUMENTE



Leksell-Stille Rongeur
15° curved jaw
24,0 cm



3x16 mm	4x16 mm	5x16 mm	6x16 mm	7x16 mm	8x16 mm
9-1360	9-1362	9-1363	9-1364	9-1365	9-1366



Leksell-Stille Rongeur
50° curved jaw
24,0 cm

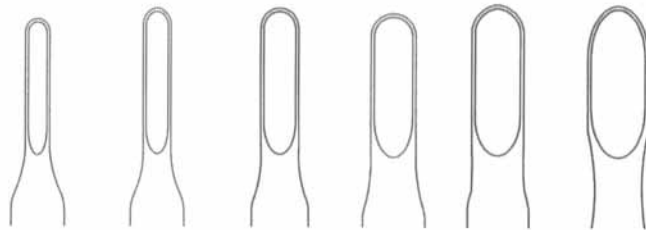

3x16 mm	4x16 mm	5x16 mm	6x16 mm	7x16 mm	8x16 mm
9-1420	9-1421	9-1422	9-1423	9-1424	9-1428



TREU - INSTRUMENTE



9-1370
Stille Ruskin Rongeur
curved
8 x 14 mm bite
23,0 cm



9-1369
Stille Luer Echlin Rongeur
curved on side
straight 6 x 15 mm bite
23,0 cm



9-1468
Marquardt Rongeur
slightly curved
3 x 15 mm bite
20,0 cm



TREU - INSTRUMENTE

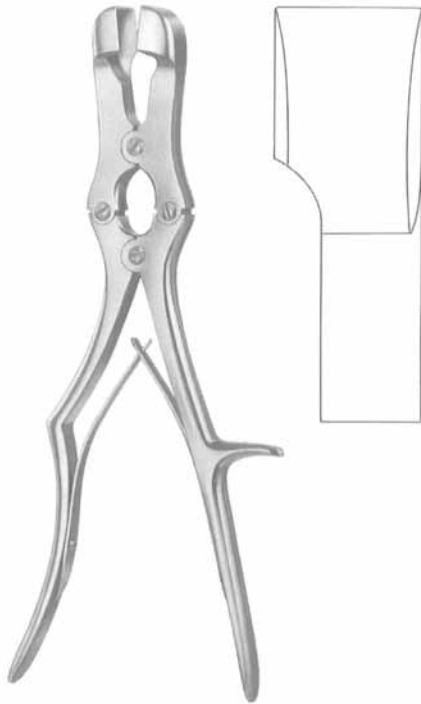

9-1430
Sauerbruch Rongeur
square 20x20 mm bite
31,0 cm

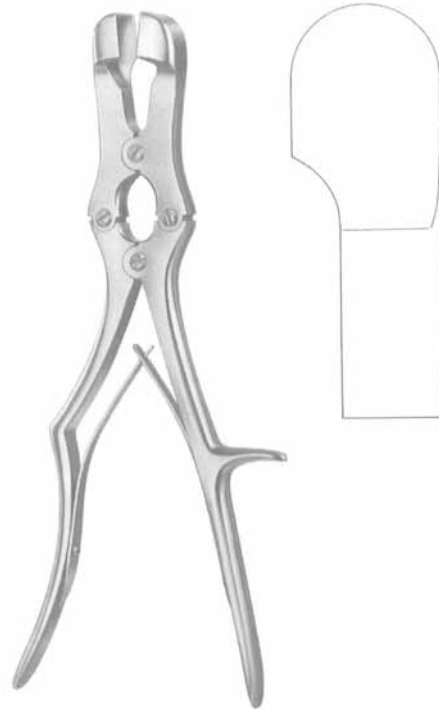

9-1432
Sauerbruch Rongeur
oval 20x20 mm bite
31,0 cm



Stille-Luer Rongeur
27,0 cm



9-1440
17 x 24 mm
straight



9-1442
17 x 24 mm
curved



9-1444
Semb Rongeur
23,0 cm



round 17 mm bite



TREU = INSTRUMENTE



Sybert Rongeur
36,0 cm

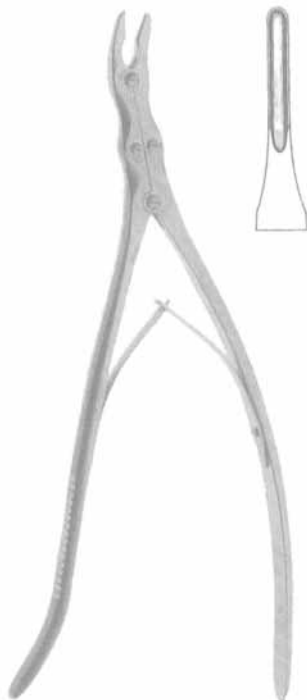
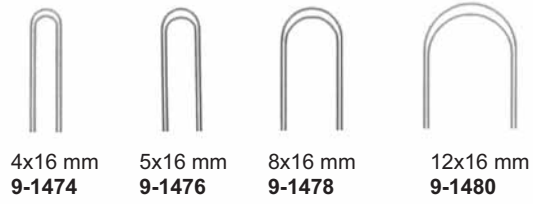

9-1469
Dale Rongeur
curved 3x16 mm bite
34,0 cm

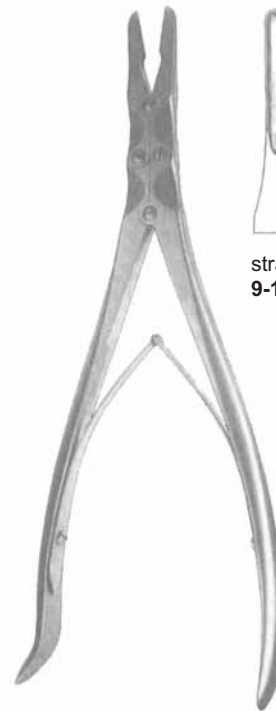

Smith Peterson Rongeur
3x16 mm bite
24,0 cm

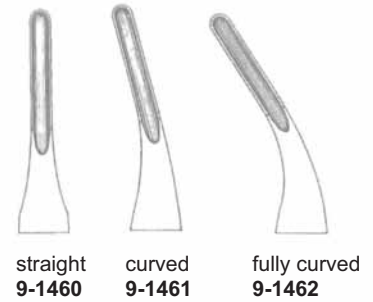



TREU = INSTRUMENTE



9-1252 Gigli Handle



- 9-1260** Gigli Saw, stainless 30 cm
- 9-1262** Gigli Saw, stainless 40 cm
- 9-1264** Gigli Saw, stainless 50 cm
- 9-1266** Gigli Saw, stainless 70 cm



9-1270 De Martel 31 cm, Saw Guide



TREU = INSTRUMENTE

Interchangeable Gouges, Chisel and Impactors



25,0 cm



9-1560
6x16 mm



9-1562
10x20 mm



9-1564
10x30 mm



9-1566
8 mm



25,0 cm

straight
9-790 5 mm
9-792 10 mm
9-794 15 mm



25,0 cm

curved
9-796 5 mm
9-798 10 mm
9-800 15 mm



9-1470 Putti, 30,0 cm



TREU = INSTRUMENTE

Tamps

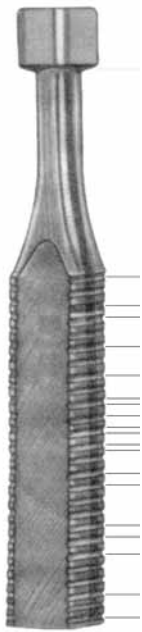

9-1600
Bone Impactor
6½" with nylon cap
aluminium handle

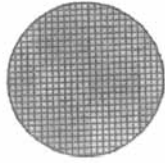

Tap grafts into place with minimal bone trauma. Grid pattern on nylon cap helps prevent slippage.



9-1620
Bone Tamp 43,0 cm
round 3/8" serrated end



TREU - INSTRUMENTE

Trephine Bone Saws

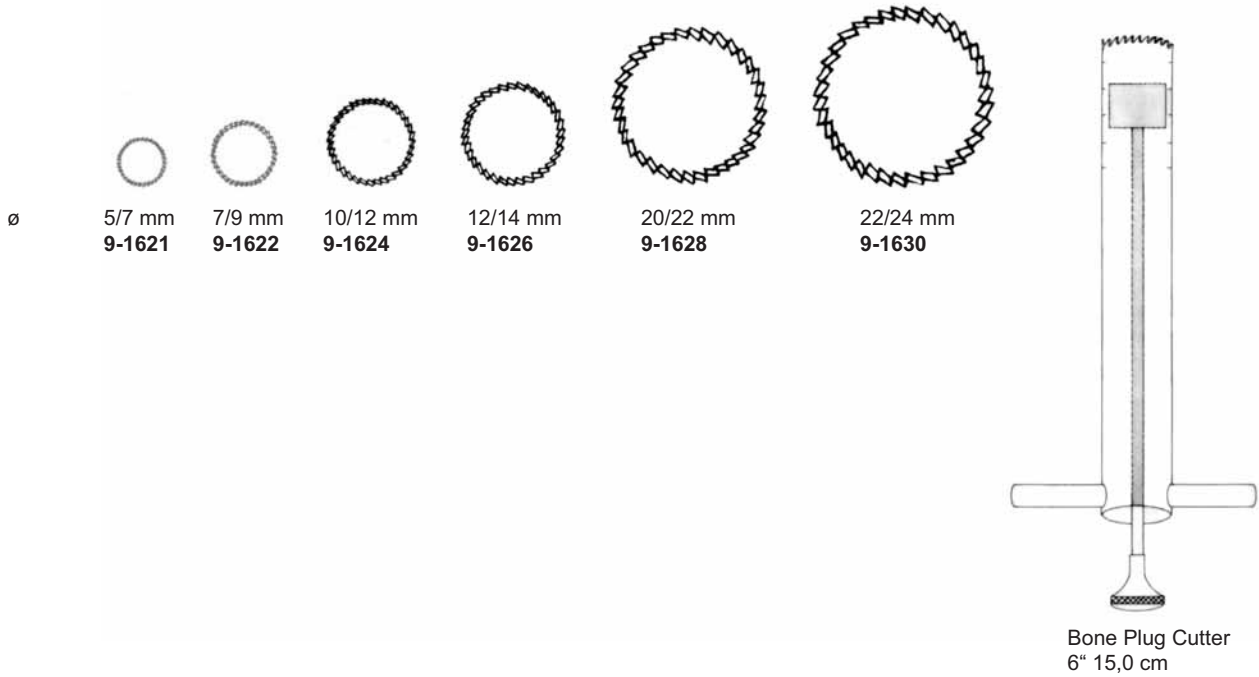

Designed for bone biopsy
Can also be used to help
remove broken bone screws

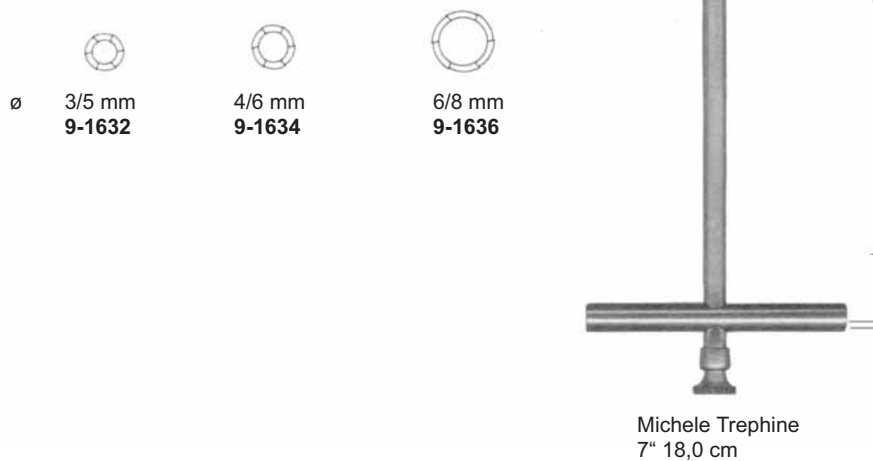



TREU = INSTRUMENTE

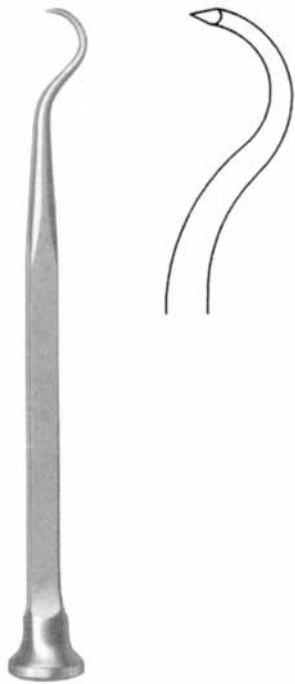

9-1660
Shoulder Percussion Awl
small curve
8½" 22,0 cm

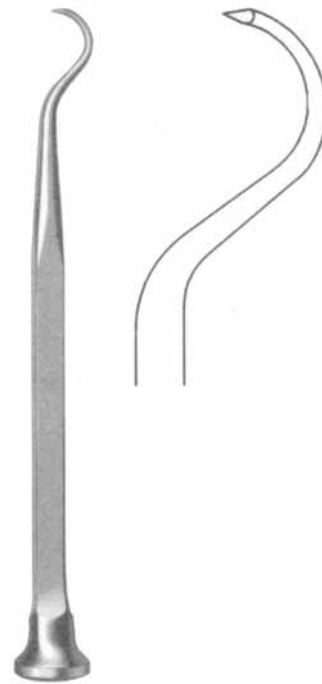

9-1662
Shoulder Percussion Awl
medium curve
8½" 22,0 cm

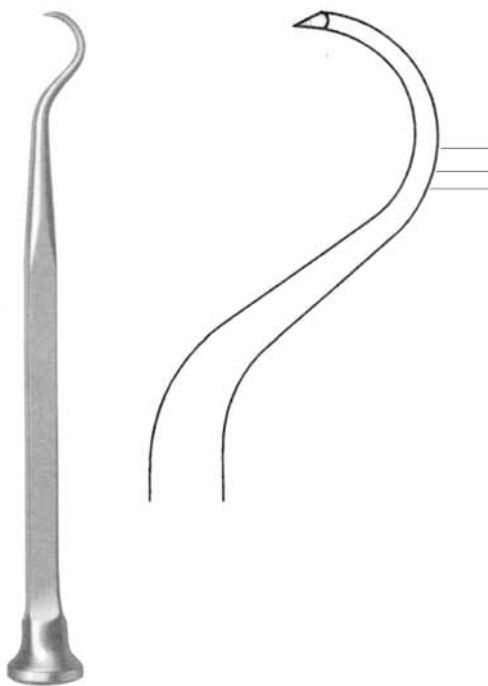

9-1664
Shoulder Penetrating Awl
phenolic handle
small curve
9¼" 24,0 cm

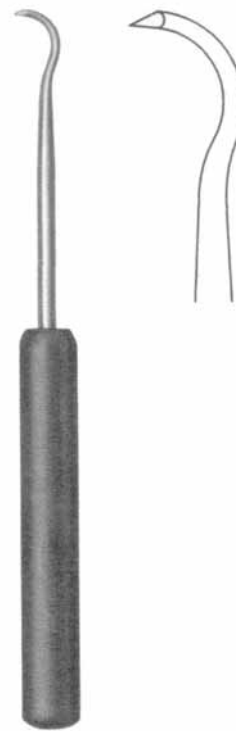

9-1666
Shoulder Percussion Awl
large curve
8½" 22,0 cm



TREU - INSTRUMENTE

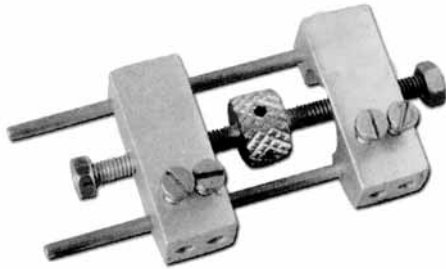

9-1690
Mini Distractor for Forearm

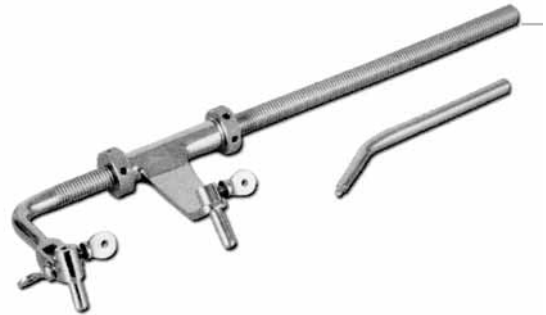

9-1692
Small Distractor for Tibia



9-1694
Large Distractor for Tibia & Femur

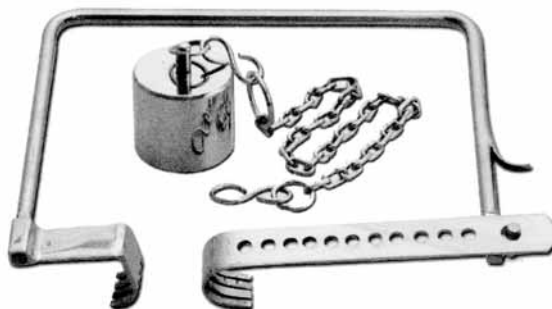

9-1696
Initial Incision Retractor with Weight & Chain



TREU - INSTRUMENTE

Instrument Set for Removal of Broken Screws

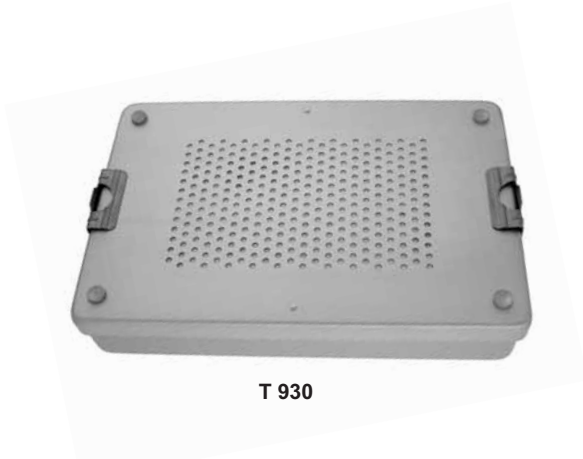

T 930

15-2026 Aluminium Case, small, silver,
15-21500 Tray for Instrument (2 pcs.)

Lid perforated-Bottom non perforated



L (mm)	B (mm)	H (mm)
300	140	100

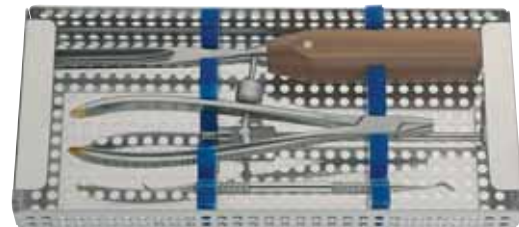

Hollow Reamers, Complete, to Expose Broken Screws

9-1766 for 3.5 mm dia. screws
9-1768 for 4.5 mm dia. screws
9-1770 for 6.5 mm dia. screws } reamers cut counter, clockwise

Extraction Bolts to Remove Broken Screws

9-1778 for 3.5 mm dia. screws
9-1780 for 4.5 mm dia. screws
9-1782 for 6.5 mm dia. screws } with inner counter-clockwise threads

Conical Extraction Screws to Remove with damaged hexagonal sockets

9-1750 for screws with 1.5 mm dia. hexagonal recess
9-1752 for screws with 2.5 mm dia. hexagonal recess
9-1754 for screws with 4.5 mm dia. hexagonal recess } with counter-clockwise threads

General Instruments

9-792 Hollow Gouge to expose broken screws
9-1820 Forceps for broken screw removal

9-1822 Tap Handle with quick coupling
9-116 Sharp hooks
9-1824 AI-Template Manual for use



TREU = INSTRUMENTE

Instrument Set for Removal of Broken Screws



Conical Extracting Screws

- 9-1750 For screws with a 1,5 und 2,0 mm hexagonal recess
- 9-1752 For screws with a 2,7 / 3,5 / 4,0 mm hexagonal recess
- 9-1754 For screws with a 4,5 und 6,5 mm hexagonal recess



Hollow Reamers, complete

to expose broken screws
cuts counter, clockwise

- 9-1822 Used with Tap Handle
- 9-1760 For screws with dia., outer 1,5 mm
- 9-1762 For screws with dia., outer 2,0 mm
- 9-1764 For screws with dia., outer 2,7 mm
- 9-1766 For screws with dia., outer 3,5 / 4 mm
- 9-1768 For screws with dia., outer 4,5 mm
- 9-1770 For screws with dia., outer 5,0 / 6,0 / 6,5 / 7,0 mm



Extraction Bolts

For removal of broken screws. With internal left-hand thread which bites into screw during unthreading.

- 9-1822 Used with Tap Handle
- 9-1772 For screws 1,5 mm dia., outer 1,5 mm
- 9-1774 For screws 2,0 mm dia., outer 2,0 mm
- 9-1776 For screws 2,7 mm dia., outer 2,7 mm
- 9-1778 For screws 3,5 mm dia., outer 3,5 / 4,0 mm
- 9-1780 For screws 4,5 mm dia., outer 4,5 mm
- 9-1782 For screws 6,5 mm dia., outer 5,0 / 6,0 / 6,5 / 7,0 mm



Spare Centering Pins

- 9-1786 For Hollow Reamer 9-1760
- 9-1788 For Hollow Reamer 9-1762
- 9-1790 For Hollow Reamer 9-1764
- 9-1792 For Hollow Reamer 9-1766
- 9-1794 For Hollow Reamer 9-1768
- 9-1796 For Hollow Reamer 9-1770



Spare Reamers (reamer tubes)

- 9-1800 For Hollow Reamer 9-1760
- 9-1802 For Hollow Reamer 9-1762
- 9-1804 For Hollow Reamer 9-1764
- 9-1806 For Hollow Reamer 9-1766
- 9-1808 For Hollow Reamer 9-1768
- 9-1810 For Hollow Reamer 9-1770



9-1820
Forceps for Broken Screws
200 mm



9-1822
Tap Handle 160 mm



9-792
10 mm



TREU = INSTRUMENTE